

SCHEMA D'IDENTIFICATION

Ligne d'arbre



welite-group.com

Merci de remplir ce formulaire avec le maximum d'informations, puis cliquez sur le bouton envoyer.

Fabricant :

MERCEDES-BENZ MAN IVECO VOLVO DAF RENAULT

Autre : _____

A1

A2

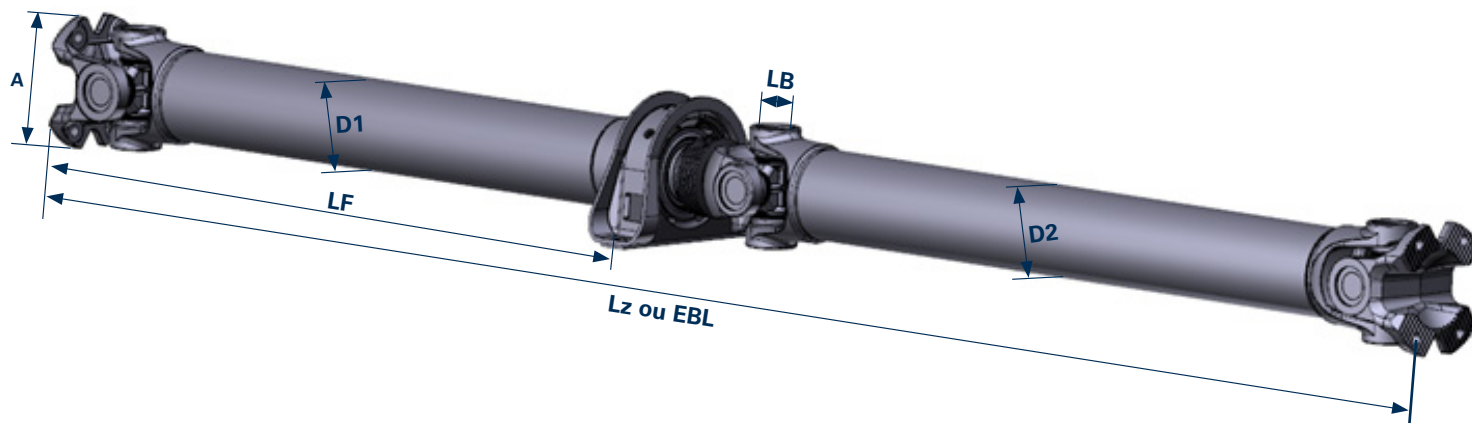

Lz (Longueur fermée)		mm
EBL (Longueur de montage/travail)		mm
LF (Longueur bride - axe palier)		mm
D1 / D2 (Diamètre du tube)	mm	mm

	A1	A2
A (Diamètre de la bride) A1/A2	mm	mm
Nombre de trous A1/A2	Trous	Trous
B (Diamètre des trous) A1/A2	mm	mm
LB (Diamètre du coussinet) A1/A2	mm	mm

Type de fixation

Denture Croisée XS

Femelle DIN

Mâle SAE

NCV 3

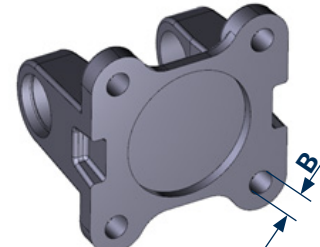
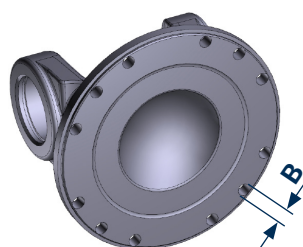
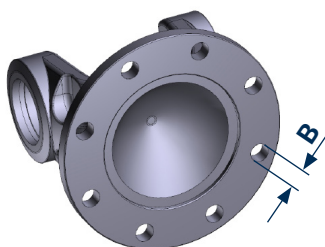
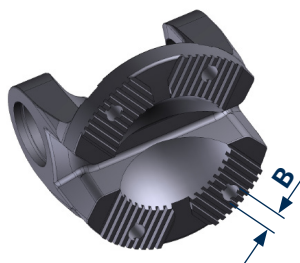

Type de lubrification

Graissage centralisé

Sans entretien

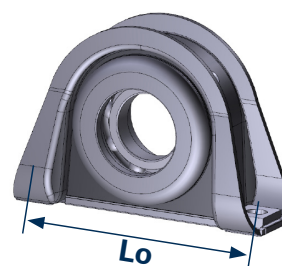
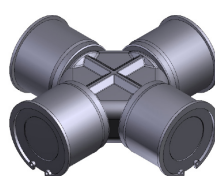
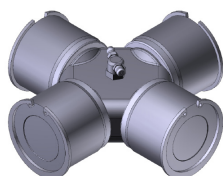

Lo (entraxe) : _____ mm